

TABLE OF CONTENTS

EN

General information	2
Purpose of the manual.....	2
Identification of manufacturer and equipment.....	3
Safety information	3
Safety regulations.....	3
Safety devices.....	4
Safety signals.....	5
Technical information	6
Technical specifications.....	6
General description of the appliance.....	7
Main parts.....	8
Installation	9
Packing and unpacking.....	9
Planning of system installation.....	9
Preparation and marking the boundaries of the work areas.....	10
Slopes.....	13
Steep slopes.....	13
Possible elements inside the work area and relative safety distances.....	14
Adjustments	15
Adjustment recommendations.....	15
Adjustment of cutting height.....	15
Use and operation	16
obllGatlons foR Use.....	16
Description of robot commands.....	16
Meaning of led combinations.....	16
Start-up.....	17
Start-up via app.....	18
Operation with delayed start.....	18
Starting the robot with the sensors turned off.....	19
Robot safety stop.....	21
Robot stop.....	22
Prolonged inactivity and restarting.....	22
Battery recharge after prolonged inactivity.....	23
Operating tips.....	23
Ordinary maintenance	24
Maintenance recommendations.....	24
Scheduled maintenance table.....	24
Robot cleaning.....	24
Troubleshooting guide	25
Troubleshooting.....	25
Part replacement	27
Recommendations for replacing parts.....	27
Battery replacement.....	27
Blade replacement.....	27
Robot disposal.....	28
Ec declaration of conformity	29

Reproduction, even partial, of this document without written permission by the manufacturer is strictly forbidden. The manufacturer assumes a policy of continual improvement and reserves the right to modify this document without prior notice on condition that the changes do not constitute health and safety risks.
© 2008 – Text, illustrations and page layout by Tipolito La Zecca. The text may be reproduced, in whole or in part, on condition that the author is mentioned.

PURPOSE OF THE MANUAL

- This manual forms an integral part of the appliance and was produced by the Manufacturer to provide the necessary information to people authorised to interact with it during its working life.
- Operators of the appliance must adopt correct working practices and must carefully read and follow all the instructions contained in this manual.
- This manual is written by the Manufacturer in the original language of Italian and may be translated into other languages to meet legal and/or commercial requirements.
- Carefully read the instructions contained in this manual to avoid any unnecessary risks to people's health and safety, as well as economic damages.
- Keep this manual in a safe and easily accessible place for quick reference.
- Some information and illustrations contained in this manual may not perfectly correspond with the appliance in your possession; however, this does not affect its functioning.
- The Manufacturer reserves the right to make changes without any obligation to provide prior notice.
- The following symbols are used throughout this manual to highlight some particularly important information or to identify some important specifications.



Danger - Attention

This symbol indicates situations involving imminent danger, which, if ignored, could put people's health and safety at risk.



Warning – Caution

This symbol indicates situations where it is necessary to behave in a certain way in order to avoid putting people's health and safety at risk, and to protect the device.



Important

This symbol identifies particularly important technical information which must not be ignored.

IDENTIFICATION OF MANUFACTURER AND EQUIPMENT

The nameplate shown here is applied directly onto the appliance. It contains references and all the information essential for safely operating the device.

For any technical requirements, please contact the Manufacturer's Technical Service Centre or an authorised dealer.

For technical assistance, please indicate the data reported on the identification plate, the approximate hours of use and the type of fault detected.

- A. Name of manufacturer.
- B. CE conformity label.
- C. Model and Version / serial number / manufacturing year.
- D. Technical data: voltage, current, protection rating, mass, cutting width.

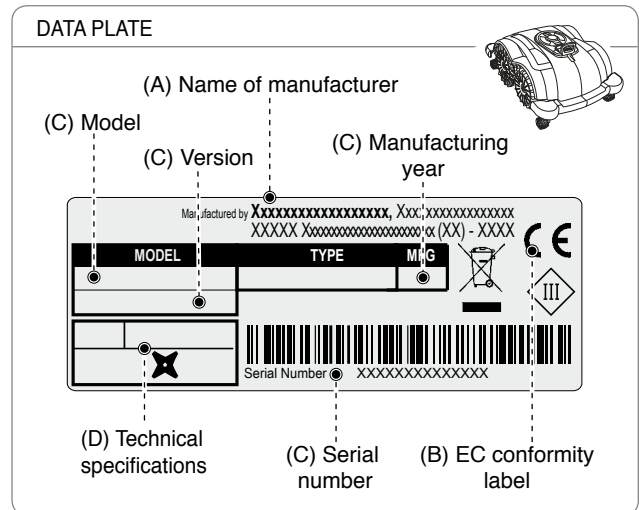

SAFETY INFORMATION

The manufacturer carefully considered the possible hazards and personal risks that may result from interacting with the equipment. The purpose of this information is to inform users on the need to use extreme caution in order to avoid risks.



SAFETY REGULATIONS



THIS PRODUCT COMES WITH A BLADE AND IS NOT A TOY!

- Please read the manual carefully, especially the safety instructions, and make sure you understand them fully before using the product. Only use the equipment for the purposes specifically intended by the manufacturer. Carefully follow the instructions on operation, maintenance and repair.
- When using the robot, make sure there is no one in the working area, in particular children, the elderly or disabled and pets. Otherwise, program the robot to operate during hours when there is no one in this area. Keep an eye on the robot if you know that pets, children or other people are in the area. If a person or animal is found on the robot's path, stop it immediately.
- Monitor the robot when it is operating in areas next to public or private areas that are not securely fenced off.
- This robot is not suitable for use by children and people with reduced physical, sensory or mental capabilities or inexperienced people who are not familiar with the product, unless they are supervised by a person responsible for their safety or have received instructions on how to use the appliance. Children should be supervised to ensure that they do not play with the appliance.
- Do not allow the robot to be used by people who do not know how it works.
- Operators who perform maintenance and repair work must be fully conversant with its special features and safety regulations. Before using the robot, carefully read the operating manual and make sure you understand the instructions.
- Never remove, bypass or tamper with the safety devices installed. The Manufacturer shall not be held liable if non-original spare parts are used. Failure to comply with this requirement may seriously endanger the health and safety of people.
- Check that there are no toys, tools, branches, clothing or other objects on the lawn which can damage the blades. Any objects on the lawn can also damage or prevent the correct functioning of the robot.

- Never allow people to sit on the robot. Never lift the robot to inspect the blade or to carry it while it is running. Do not place hands and feet under the robot when it is in operation.
- Do not use the robot when a sprinkler system is running. In this case, program the robot and the sprinkler system so that they do not operate at the same time. Do not wash the robot with high-pressure water jets and do not immerse it in water, partially or completely, as it is not watertight.
- Disconnect the power supply and activate the safety device before performing any adjustment or maintenance that the user is authorised to perform. Use the personal protection devices recommended by the Manufacturer, in particular, always wear protective gloves when handling the cutting blade.
- Cleaning and maintenance must not be performed by unsupervised children.
- Do not use the robot when the cutting blade is damaged. Replace the cutting blade.
- Do not use the robot with damaged external parts. If the mechanical parts of the robot are damaged, replace them.
- Do not use the robot if the power cord of the transformer is damaged. A damaged cord can lead to contact with live parts. To avoid any risk, have the cord replaced by the manufacturer or by its technical service centre or by a person with similar qualifications.
- Visually check the robot regularly to make sure the blade, mounting screws and cutting mechanism are not worn or damaged. Make sure that all the nuts, bolts and screws are tightened to ensure that the robot is in good working condition.
- If the robot starts to vibrate abnormally during use, press “STOP” and disconnect the power cord from the electrical socket.
- Never use and recharge the robot in explosive and/or flammable environments.
- Only use the battery charger and power supply unit supplied by the manufacturer. Improper use may cause electric shocks, overheating or leakage of corrosive liquids from the battery. If any liquid leaks, wash the battery with water/neutraliser; in case of contact with eyes, seek medical attention.

SAFETY DEVICES

1. Bumpers

The bumper sensor is activated if the robot strikes a solid object greater than 9 cm (3.54 ") in height, which stops the movement in that direction and moves backwards to avoid the obstacle.

2. Inclinometer

If the robot works on a slope which is steeper than the maximum limit, or tips over, the robot will stop the cutting blade.







3. Emergency stop switch

Located on the control panel with the word “STOP” larger than the other commands on the keypad. Pressing this button at any time during operation will immediately stop the movement of the lawnmower robot and the rotation of the blade will stop.

4. Over-current protection

Each motor (blade and wheels) is monitored continuously during operation for any situation that may cause them to overheat. If this occurs in the wheel motor, the robot will attempt to move in the opposite direction. If the over-current persists, the robot will stop and signal an error. If the cutting blade motor overheats, there are two intervention ranges. If the parameters fall within the first range, the robot will perform the manoeuvres to unblock the cutting blade. If the over-current is below the protection range, the robot will stop and signal a motor error.

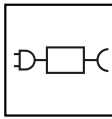
SAFETY SIGNALS

	<p>Read user instructions carefully to understand meanings before using the machine.</p>		<p>Keep an adequate safe distance from the machine while it is running.</p> <p>While the robot is working, make sure there are no people in the working area (especially children, elderly or disabled people) and pets. Keep children, pets and other people at a safe distance when the machine is functioning. To prevent that risk, we advise scheduling the robot's mowing activities at suitable times.</p>
	<p>Do not touch the rotary blade and do not place your hands or feet underneath the machine when it is running. Wait until the blade and rotating parts come to a complete stop before accessing.</p>		<p>Warning! Do not spray water on the machine to clean or wash it.</p> <p>While the robot is working, make sure there are no people in the working area (especially children, elderly or disabled people) and pets. Keep children, pets and other people at a safe distance when the machine is functioning. To prevent that risk, we advise scheduling the robot's mowing activities at suitable times.</p>
	<p>Do not ride on the machine.</p>		<p>Use the robot only with the power supplies indicated in the "Technical Data" of the "Technical Information" chapter.</p>
	<p>Operate the safety device before working on or lifting the machine.</p>		

TECHNICAL INFORMATION

TECHNICAL SPECIFICATIONS

EN

Description		Model	
		7060DE0	
Maximum recommended surface that can be mowed			
Working capacity (-20%(*))	m ² (sq ')	200 (2150')	
Features			
Dimensions (W x H x D)	mm	409x199x335	
Robot weight (incl. battery)	kg	8,3	
Cutting height (Min-Max)	mm (")	42-48 (1.65-1,88 ")	
Diameter of blade with 4 cutting edges	mm (")	250 (9,84 ")	
Drive system		4WD	
Cutting blade speed	RPM	4000 cutting	
		3000 maintenance	
Ground speed	Metres / Minute	18 (59 ')	
Maximum recommended slope managed (*)	%	50%. Allowable, based on the lawn conditions and accessories installed. 40%. maximum managed and recommended in conditions of a trimmed lawn.	
Ambient operating temperature	Max °C	ROBOT -10°(14 F.) (Min) +42° (107 F.) (Max) BATTERY CHARGER -10°(14 F.) (Min) +40° (104 F.) (Max)	
Measured noise level	dB(A)	65	
Water protection class	IP	IP21	
Electrical features			
Power supply unit (for lithium battery)		Mean Well OWA-60E-30ZCT Input: 100 - 240 V~; 1.2 A; 50/60 Hz; Class 2 Output: 29.4 V ==; 2.0 A;	
Type of accumulator and charging batteries			
Rechargeable Lithium-Ion Battery		25.9V - 5.0Ah	
Battery charger		29.4 Vcc - 2,0 Ah	
Average recharging time	hh:mm	3:00	
Average mowing duration after a full charge cycle (*)	hh:mm	2:00	

(*) Depends on the condition of the grass, lawn and the complexity of the mowing area.

Equipment / Accessories / Functions		
Grass detection sensor (patented)	N.	6
Curb drop-off sensors (Step)		standard
Mowed lawn detection sensors		standard
8-pronged blade		Specifically for early season rapid growth and for lawns that need greater mowing power. optional

(*) Depends on the condition of the grass, lawn and the complexity of the mowing area.

GENERAL DESCRIPTION OF THE APPLIANCE

The appliance is a robot designed and built to automatically cut grass in gardens and lawns at any time of the day.

It is small, compact, silent and easy to handle depending on the type of lawn that is being mowed.

During operation, the robot mows the area delimited by paving and/or barriers (fences, walls, etc.).

When the robot detects that there is no grass or encounters an obstacle, it changes route in a random manner and starts mowing again in a new direction.

Based on its operating principle ("random"), the robot automatically mows the entire delimited area of the lawn (see figure).

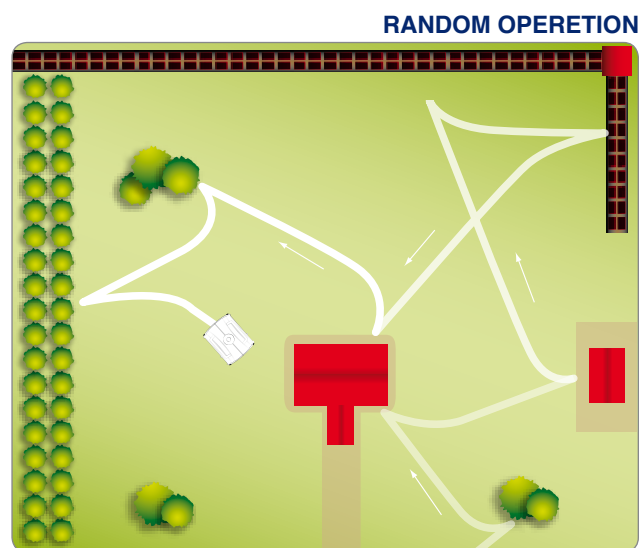

The maximum lawn surface that the robot can mow depends on a series of factors, such as:

- the characteristics of the area (irregular perimeters, uneven surfaces, divided areas, etc.).
- the characteristics of the lawn (type and height of the grass, humidity, etc.).
- the condition of the blade (level of sharpness, grass or debris buildup, etc.).
- the model of the robot and type of batteries installed.

MAIN PARTS

EN

MODEL		7060DE0
Version		A
①	Robot	✓
②	Battery	✓
③	Power Supply Unit	✓
④	Mother board	✓
⑤	Control keyboard	✓
⑥	Cutting blade	✓
⑦	Electric motor	✓
⑧	Electric motor	✓
⑨	Sensors	✓
⑩	Curb drop-off sensors	✓
⑪	User manual	✓
⑫	Charging jacks	✓

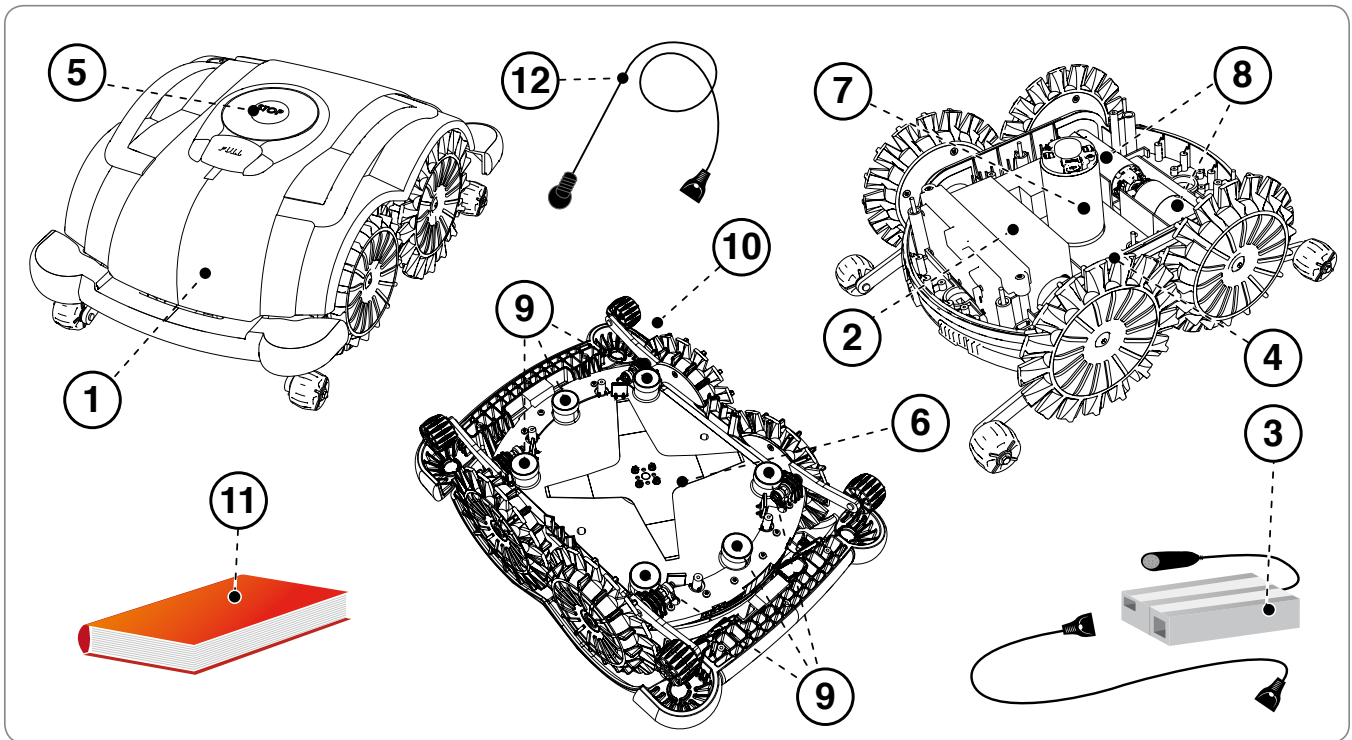

PACKING AND UNPACKING

The equipment is delivered suitably packaged. When unpacking, carefully remove and check the integrity of the parts.



Warning – Caution

Keep plastic wrapping and plastic containers away from infants and children: risk of suffocation!



Important

Keep the packaging materials for future use.

PLANNING OF SYSTEM INSTALLATION

The robot is not difficult to install, but requires some preliminary planning in order to define the best area for installing the power supply unit.

Position the power supply unit in an easy to access zone.

- The power supply unit must be in a well-ventilated area, protected from direct sunlight and exposure to the elements.
- The power supply unit must not be in direct contact with the ground or humid environments.

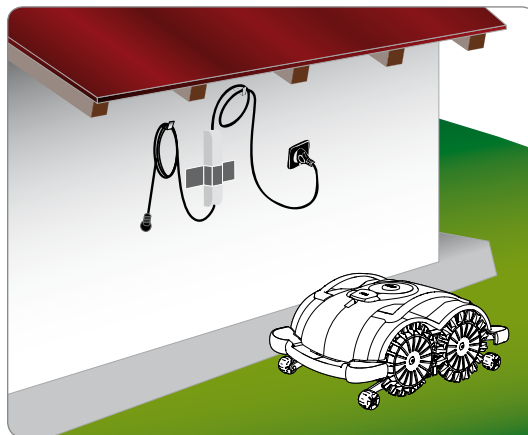

Warning – Caution

Position the power supply unit in an area that cannot be reached by children. For example, at a height above 160 cm (63 ").



Warning – Caution

When connecting the electricity, it is necessary that a power outlet is positioned near the installation area. Make sure the connection to the mains power complies with the applicable laws. To operate in complete safety, make sure the electrical system, which is connected to the power supply unit, is equipped with a well-functioning earthing system. The supply circuit shall be protected by a residual current device (RCD) with a tripping current of not more than 30 mA.



Important

It is advisable to install the unit in a cabinet for electric components (for outdoor or indoor use), equipped with a key lock, and well-ventilated to maintain a correct air circulation.



Warning – Caution

Make sure only authorised people have access to the power supply.

PREPARATION AND MARKING THE BOUNDARIES OF THE WORK AREAS

preparation of the lawn to be mowed

1. Make sure that the lawn to mow is even and does not contain holes, stones or other obstacles. Otherwise, prepare the lawn by filling in any holes and removing any obstacles. If some obstacles cannot be removed, it is necessary to properly define and protect the interested areas.
2. Check that all the areas of the lawn do not exceed the allowable slopes (see "Technical Specifications").

The sensors, which recognise the presence of the grassy surface, allow the robot to move freely inside the lawn. The lawn must be suitably checked and adjusted so that the robot has enough space for recognising when there is no grass. Carefully follow the below points for the correct and safe use of the robot.

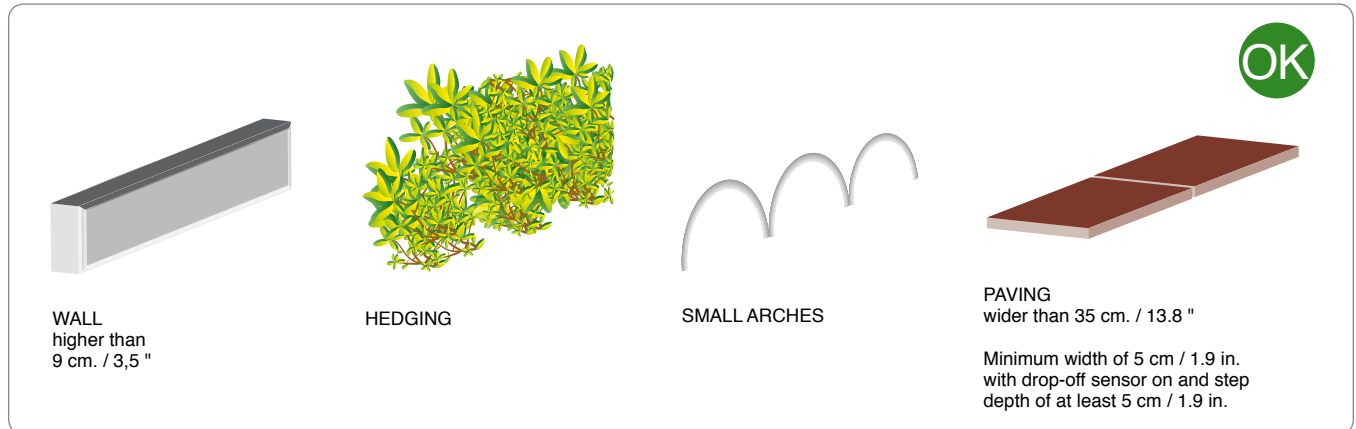

Types of boundaries/protections that can be used for correctly defining the limits of the robot's work area.

Pavement

With the drop-off sensor on, the robot requires a curb of at least 5 cm and a step depth of at least 5 cm. Curbs less than 5 cm wide or steps less than 5 cm deep must be protected with additional pavement, or alternatively, by placing arches in the ground, as shown in the figure, so that the robot can run into them and change direction.

If the robot is not equipped with a drop-off sensor or if the sensor is off, a pavement of at least 35 cm is needed for it to stop safely and change direction.

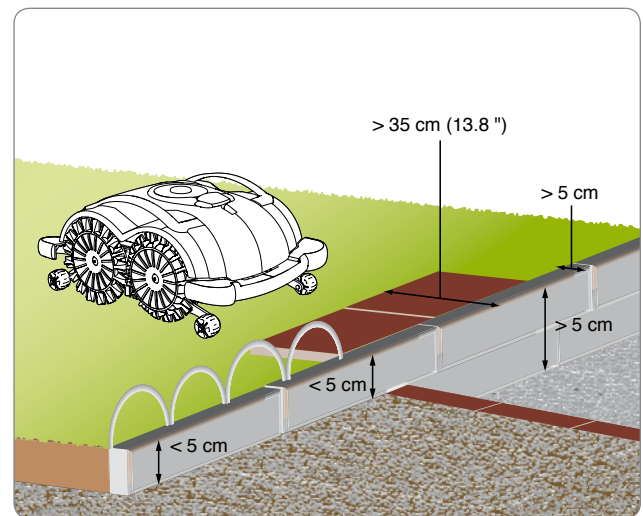

Wall

Perimeter wall, which defines the boundary of the work area at a height above 9 cm. (3.54 "). If the walls are shorter, protect the area with arches or adequate paving.

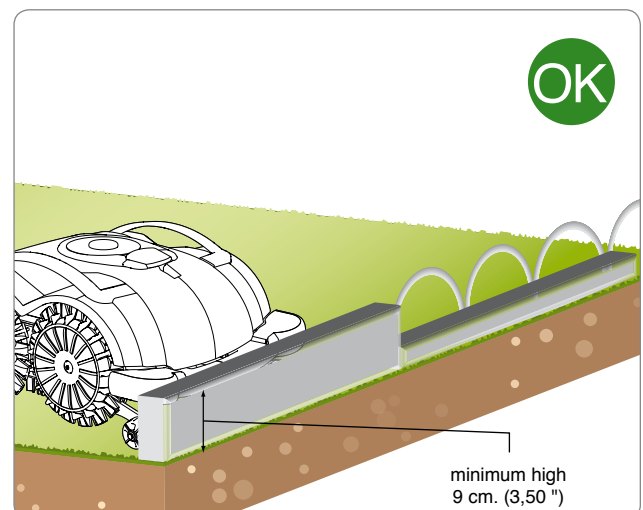

Hedging

The work area can also be effectively delimited by hedges.

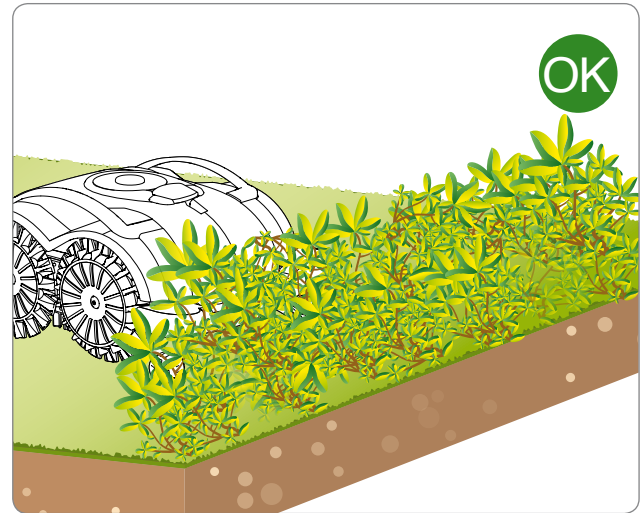

EN

Holes

The work area cannot be delimited by ditches or holes which must not be present inside the grassy area to mow. Before starting the robot, check that there are no objects on the lawn such as toys, small stones, branches or sprinklers protruding from the ground which could impede correct functioning or cause damage to the blade.

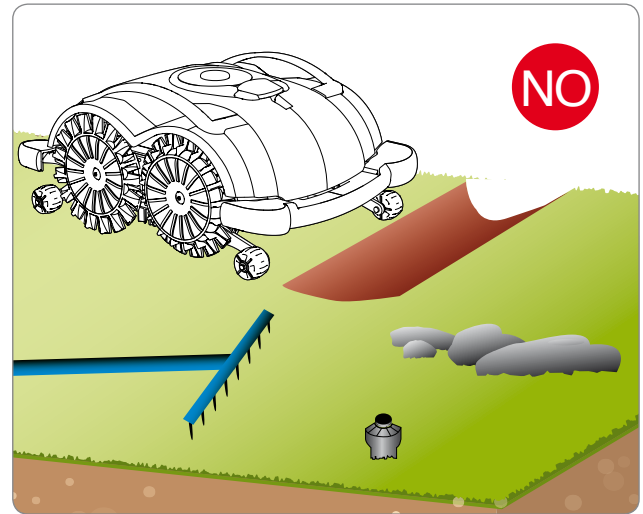

Obstacles and protections

The illustrations show an example of the internal and peripheral elements of the correct work area. If elements such as tree roots or exposed wires are present, it is necessary to delimit the perimeter of these elements with paving, walls or barriers to prevent the malfunctioning of the robot. Elements (trees, poles, etc. ref. fig. obstacles) which do not impede the robot's normal functioning do not require delimiting.



Roots

Do not, under any circumstance, leave areas which have not been delimited by barriers inside the work area, as these will prevent the robot from functioning properly (roots, external pipes, work tools, etc.).



Fine gravel



Danger - Attention

If fine gravel, leaves or small stones are used to border the lawn, they are not detected correctly by the robot. Protect the lawn with other borders.

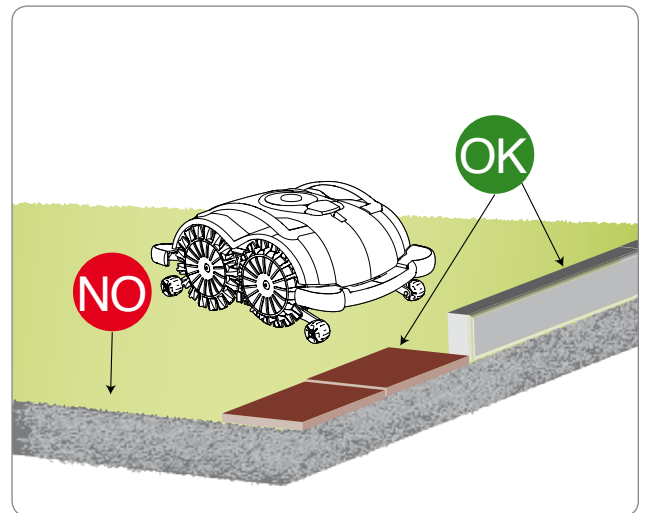

Sharp corners



Danger - Attention

In areas of the lawn that end in narrow spaces as shown in the figure, the robot cannot move easily, therefore this part of the lawn must be excluded because the robot would exit the borders.

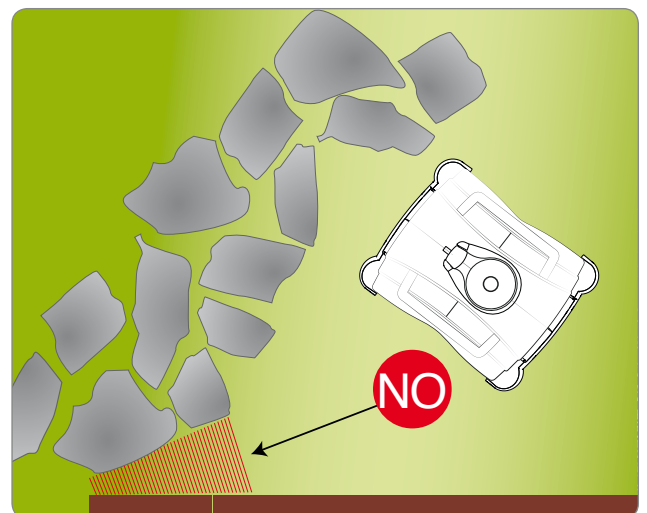

SLOPES

Check that all the areas of the lawn do not exceed the admissible slopes (see "Technical Specifications"). Areas with steeper slopes or that are incompatible with the correct functioning of the robot (see following points) cannot be mowed. Steeper slopes must be delimited.

EN



Important

The sensors of the robot can detect slopes greater than the robot can manage. The direction is reversed in order to prevent the robot from tipping over or malfunctioning. In addition, as a further protection, it is necessary to delimit the areas, which have slopes that cannot be managed. It is recommended to test the robot when using for the first time on slopes that are at the limit of the specifications.

UPWARD SLOPE

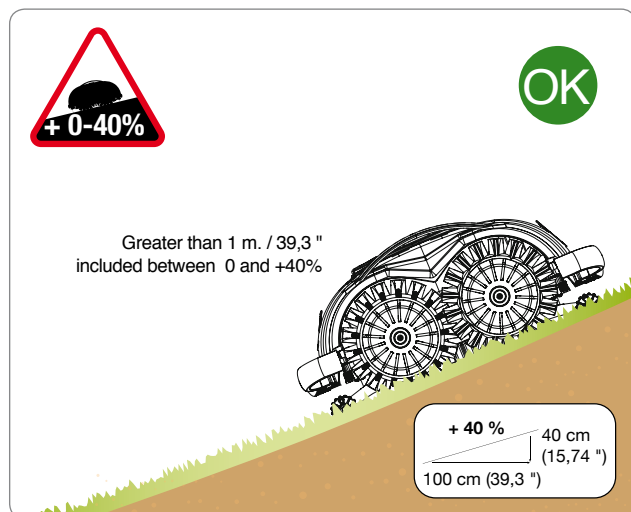

DOWNWARD SLOPE

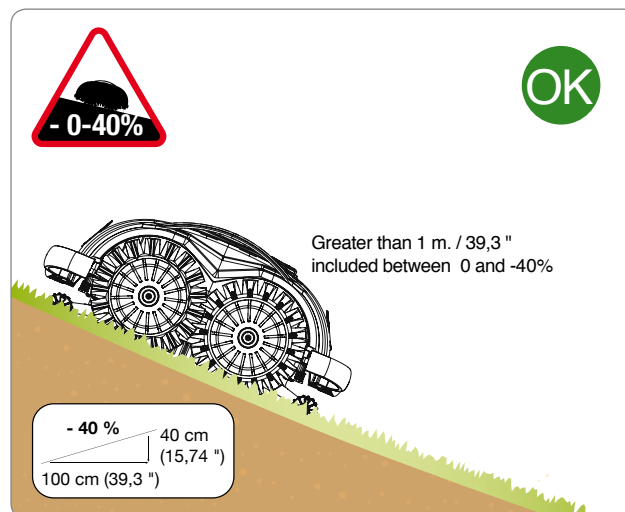

The robot can tackle height differences with a slope of up to 40% provided that they gradually slope down over a distance of more than one metre.

STEEP SLOPES

The robot's safety system will interpret sudden changes in the slope (greater than 25%) as an anomaly and therefore, will reverse the direction and bring the robot back to safety continuing to mow the lawn. Tree trunks which gradually rise from the ground or stones positioned to mark the boundary of flower-strips which gently descend onto the grassy surface are also interpreted as slope changes.



Important

Check the robot when using for the first time on slopes that are at the limit of the specifications.

UPWARD SLOPE

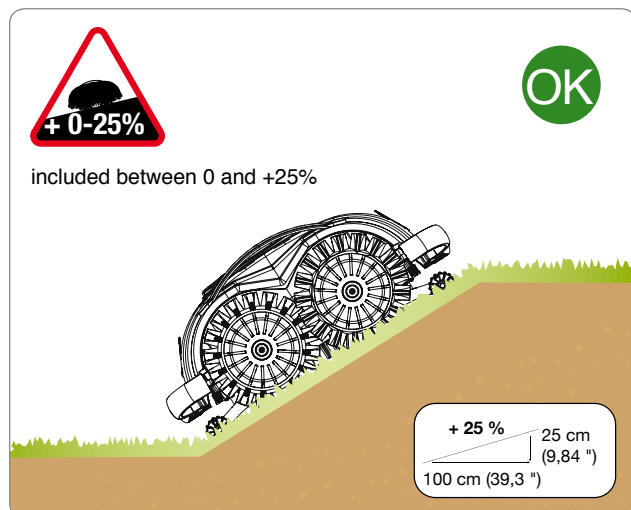

DOWNWARD SLOPE

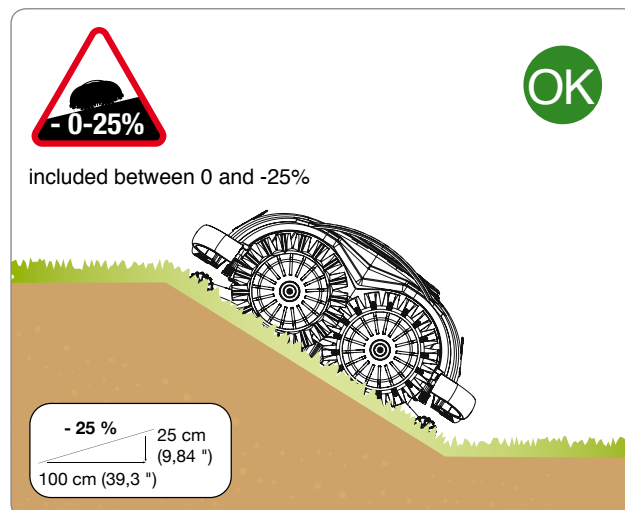

The robot can tackle height differences with slopes of up to 25% if they slope down suddenly.



Important

Areas with slopes greater than those specified cannot be mowed with the robot.

EN

POSSIBLE ELEMENTS INSIDE THE WORK AREA AND RELATIVE SAFETY DISTANCES

APPROPRIATE POOL PREPARATION

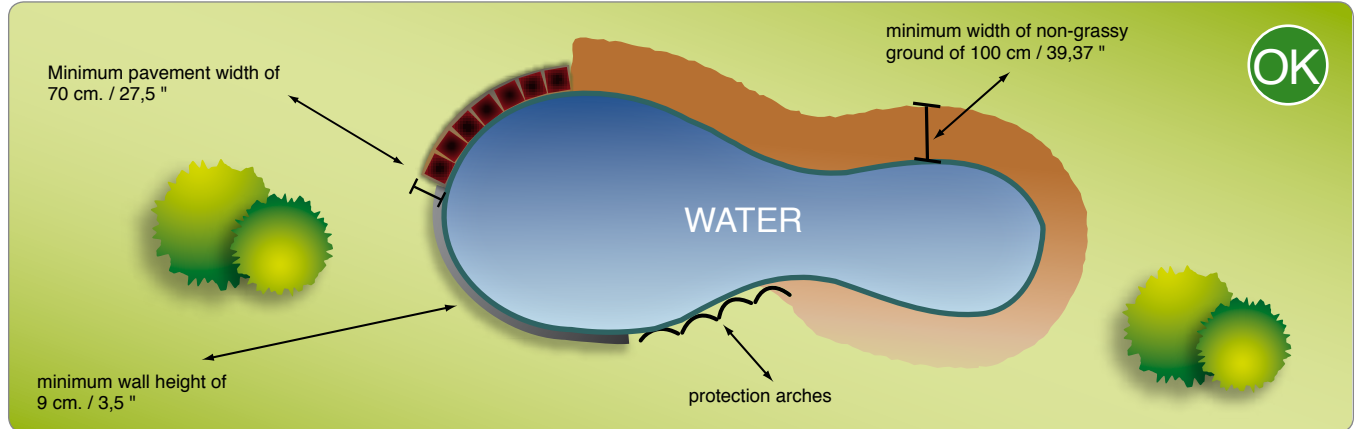

The figure above shows a work area which has been correctly delimited for the correct functioning of the robot.



Important

Foliage is usually detected as grass. In case of foliage, we suggest to increase the distance from the edge by about 20 cm (7,88 ").

INAPPROPRIATE POOL PREPARATION

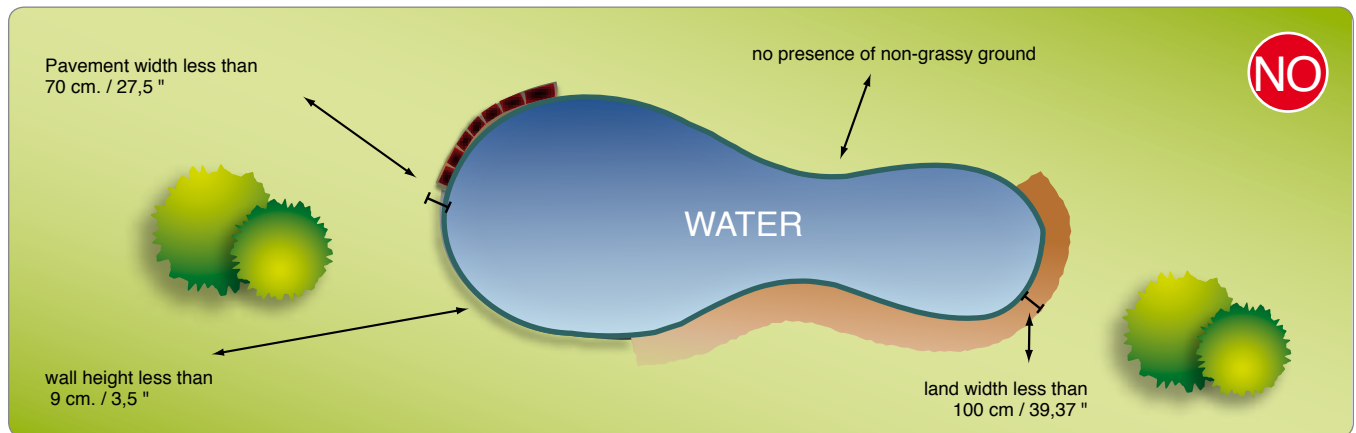

The figure above shows a work area where the robot's operating areas have not been correctly delimited, thus preventing it from functioning properly.

ADJUSTMENT RECOMMENDATIONS



Important

The user must follow the procedures described in this manual when making any adjustments. Do not make any adjustment which is not expressly indicated in this manual. Any special adjustments, not expressly indicated in this manual, must only be carried out by personnel from the Manufacturer's Authorised Service Centres.

ADJUSTMENT OF CUTTING HEIGHT

1. Stop the robot safely by pressing the "ON/OFF" key (see "Robot safety stop").
2. Turn over the robot and position it so as not to ruin the covering hood.



Important

Use protective gloves to prevent injury to your hands.

3. Unscrew the screws to remove the blade.
4. Insert or remove the spacer to adjust the cutting height.
5. Reposition the blade and fasten the screws.
6. Turn the robot over to its operating position.

INSERT SPACER AND BLADE WITH SCREWS

check that the slope of the blade, with the robot in the start position, is facing downwards.

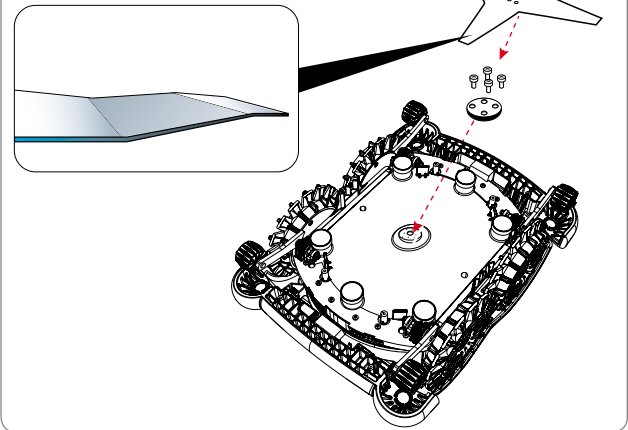

Important

Reduce the cutting height gradually. It is recommended to add the spacer every 2+3 days until the ideal height of the grassy surface is reached gradually.



Important

- When using the robot for the first time, it is recommended to carefully read the entire manual and to fully understand it, especially the safety information.
- Only use the robot for the uses intended by the Manufacturer and do not tamper with any device to obtain different performances.
- Avoid using the robot and its peripherals in bad weather conditions especially when there is a risk of lightning.

DESCRIPTION OF ROBOT COMMANDS

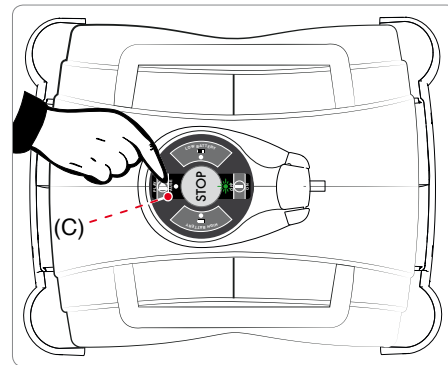
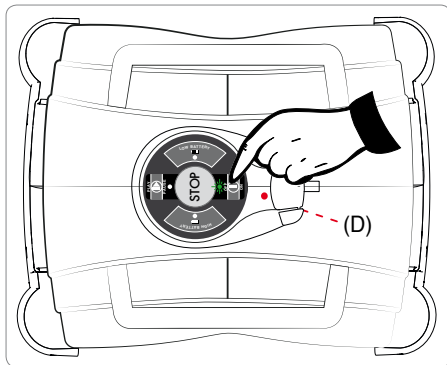

The illustration shows the position of the commands on the machine.

D. ON/OFF: press to turn the robot on and off.

C. PLAY/PAUSE: press to start or stop the robot when it is on standby.

MEANING OF LED COMBINATIONS

IN OPERATION ROBOT

A. HIGH BATTERY: ● (GREEN LED STEADY ON)
full battery level.

B. LOW BATTERY: ① (RED LED 1 FLASH)
medium battery level.

● (RED LED STEADY ON)
low battery level.

C. PLAY/PAUSE: ● (YELLOW LED STEADY ON)
in pause / in pause due to low battery.

● (YELLOW LED SLOW FLASHING)
Robot in standby. Press the PLAY/PAUSE key to display the status of the LEDs.

① (YELLOW LED 1 FLASH)
the lawn has been mowed.

② (YELLOW LED 2 FLASHES)
no lawn present.

D. ON/OFF: ● (GREEN LED STEADY ON)
robot in operation.

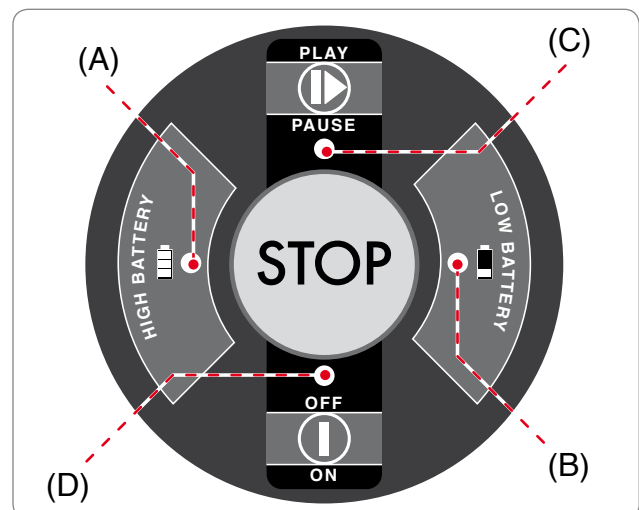

RECHARGING ROBOT

A. HIGH BATTERY: ● (GREEN LED STEADY ON)
full battery level.

① (GREEN LED 1 FLASH)
medium battery level.

B. LOW BATTERY: ● (RED LED STEADY ON)
low battery level.

C. ON/OFF: ● (GREEN LED STEADY ON)
robot in operation.

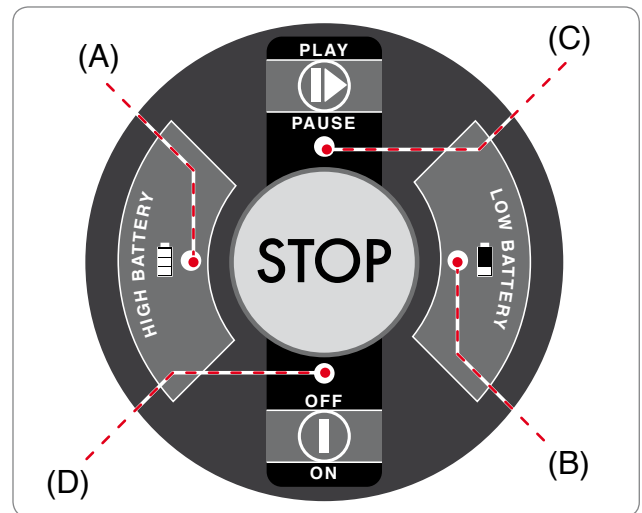

EN

START-UP

1. Check that the grassy surface of the lawn to mow is at a height which is compatible with the proper functioning of the robot (see technical specifications).
2. Adjust the desired cutting height (see cutting height adjustment).
3. Check that the work area is correctly delimited and that there are no impediments to the correct functioning of the robot as indicated in the section "Preparation and defining the boundaries of the work areas" and following sections.
4. Position the robot near the charging zone.

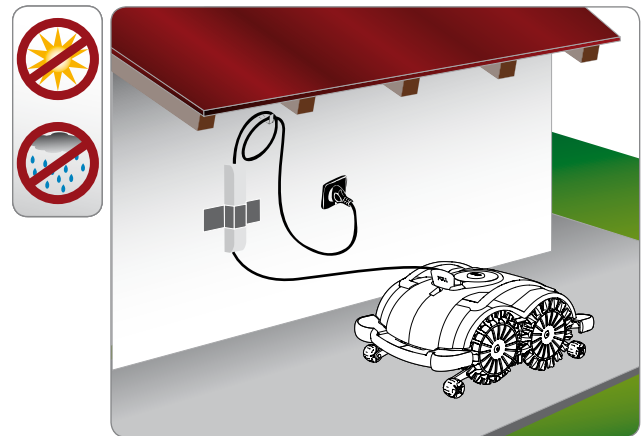

5. Lift the door of the charging connector. Insert the charging connector. Once connected, the robot turns on automatically and displays the battery charge level (see "meaning of led combination").
6. At the end of charging, disconnect the robot and press the "ON/OFF" button. On first use, always charge the batteries for at least 4 hours.
7. Position the robot inside the grassy surface in an area where the grass is at least 1 metre (40.00 ") from any obstacle.
8. Press the "OFF/ON" key and wait a few seconds for the robot to turn on completely.
9. Press "PLAY/PAUSE" key to start the robot.

Once the robot has stopped due to the reasons described in the chapter "Robot Stop", activate the safety stop and reposition the robot inside the power supply unit for recharging.



Important

For a better cutting performance and correct functioning of the recognition sensor, do not start the robot in case of rain or in very humid conditions. The best results are obtained in the middle of the day.

START-UP VIA APP

The robot has a built-in Bluetooth device that allows it to be programmed and controlled via a smartphone.

Download the application from Google Play or the Apple Store using your smartphone or tablet. Start the application and follow the wizard to pair the Robot to your device.

The factory set PIN is "0000." Change the PIN as soon as possible to make the robot safe.

The application allows you to:

- start and stop the robot;
- delay the start of the robot;
- guide the robot during the mowing cycle;
- change the status of the sensors;
- display the status, alarms and any errors.

OPERATION WITH DELAYED START

If necessary, the robot can be delayed to start by up to 24 hours.

Press the "OFF/ON" button. After a few seconds the robot switches completely on. Press briefly the "OFF/ON" button at intervals of 1 second, as many times as the hours of delay of departure.

On completion of the sequence, wait for the robot to confirm the delay setting with the sound of a beep.

The robot will be in standby until the working cycle resumes the established time.



Important

In case of errors, turn off the robot by keeping the "ON/OFF" button pressed, and resume the start-up sequence.

OPERATION WITH DELAY OPERATION

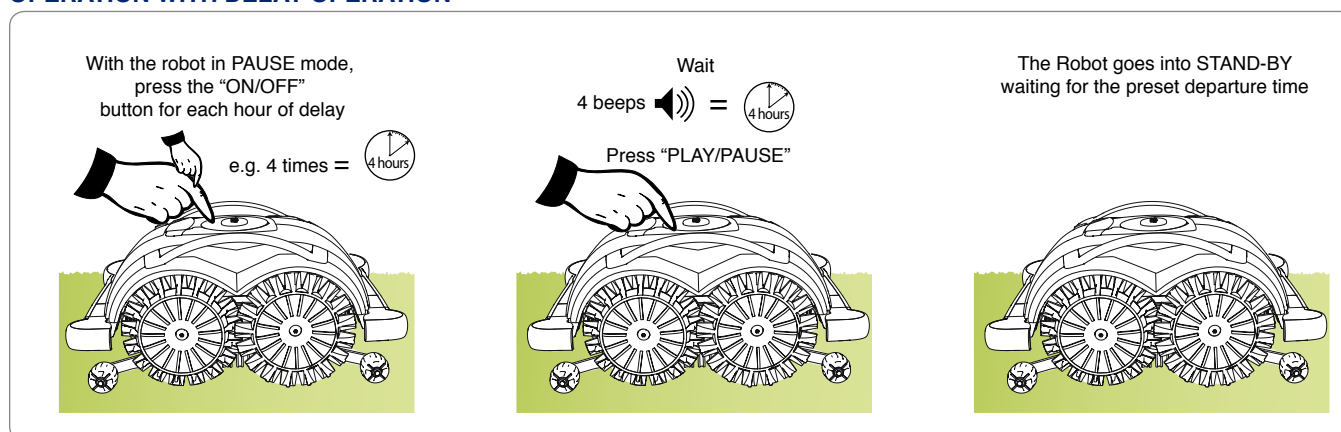

STARTING THE ROBOT WITH THE SENSORS TURNED OFF

In certain lawn conditions, the robot can be started with the lawn and curb drop-off sensors deactivated, which means the robot can be started when lawn conditions are such that correct functions are not guaranteed, for example with very short or patchy grass.

EN

This mode requires very special attention from the user, and the dealer should be consulted before attempting to operate in this mode.

When the robot is on Pause, these modes can be activated following this procedure:

Grass Sensor Off – Curb drop-off sensor On:

Press the "PLAY/PAUSE" button and keep it pressed for 4 seconds until 2 consecutive beeps are heard and the PAUSE led flashes twice. This mode must only be used on models with the curb drop-off sensor installed, and it allows working with just the 4 curb drop-off sensors. This mode is recommended in gardens where the lawn is lower than the sensors but still very uniform.

GULF

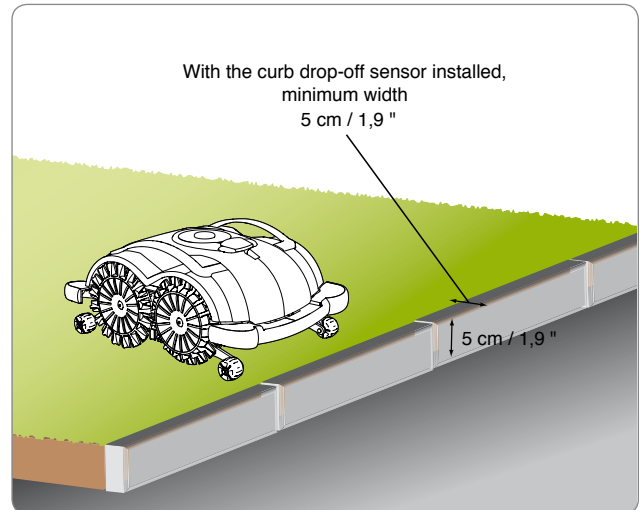

GRASS SENSOR OFF - CURB DROP-OFF SENSOR ON

Keep the "PLAY/PAUSE" button pressed for 4 seconds.

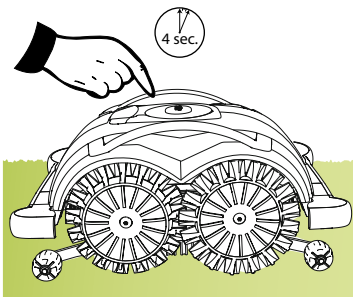

Wait for 2 beeps + 2 flashes

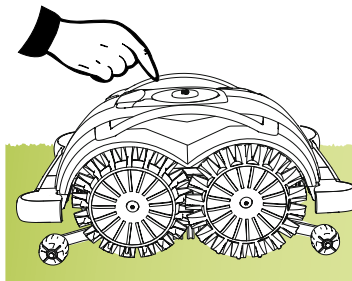

Release the button

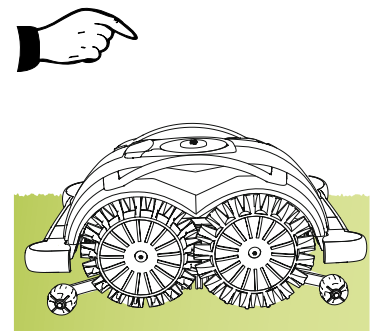

Grass Sensor On – Curb drop-off sensor Off:

GRASS SENSOR

Press the “PLAY/PAUSE” button and keep it pressed for 8 seconds until 3 consecutive beeps are heard and the PAUSE led flashes three times. This mode must only be used on models with the curb drop-off sensor installed, and it allows working with just the front grass detector sensors. This mode is recommended with uneven surfaces with lots of sharp dips or sparse grass.

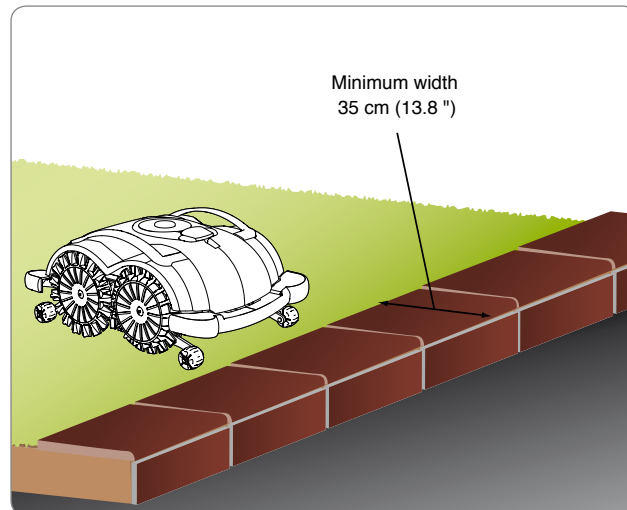

Danger - Attention

The robot requires more space with this mode to change the direction. Respect the distances that are given for models without the curb drop-off sensor.

GRASS SENSOR ON CURB DROP-OFF SENSOR OFF

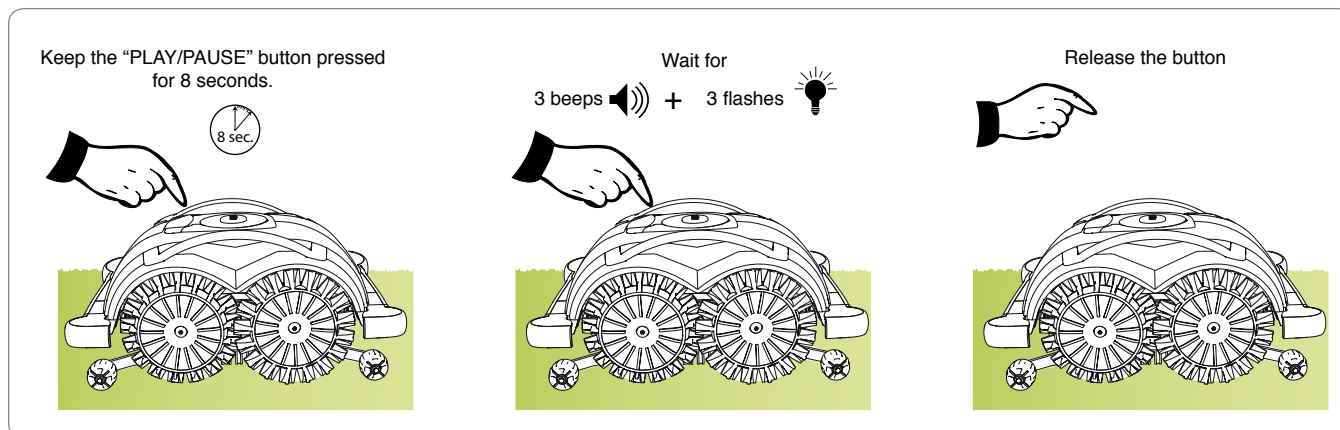

Grass Sensor Off – Curb drop-off sensor Off:

LAWN PROTECTION

Press the “PLAY/PAUSE” button and keep it pressed for 12 seconds until 4 consecutive beeps are heard and the PAUSE led flashes 4 times. This mode allows working without any sensors. It is useful in particular with poor lawn conditions. This mode should only be used if the lawn is protected by a wall, fence or hedge.

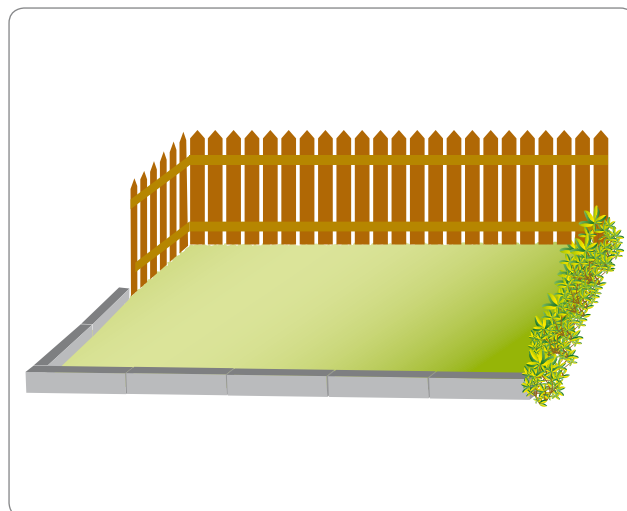

GRASS SENSOR OFF - CURB DROP-OFF SENSOR OFF

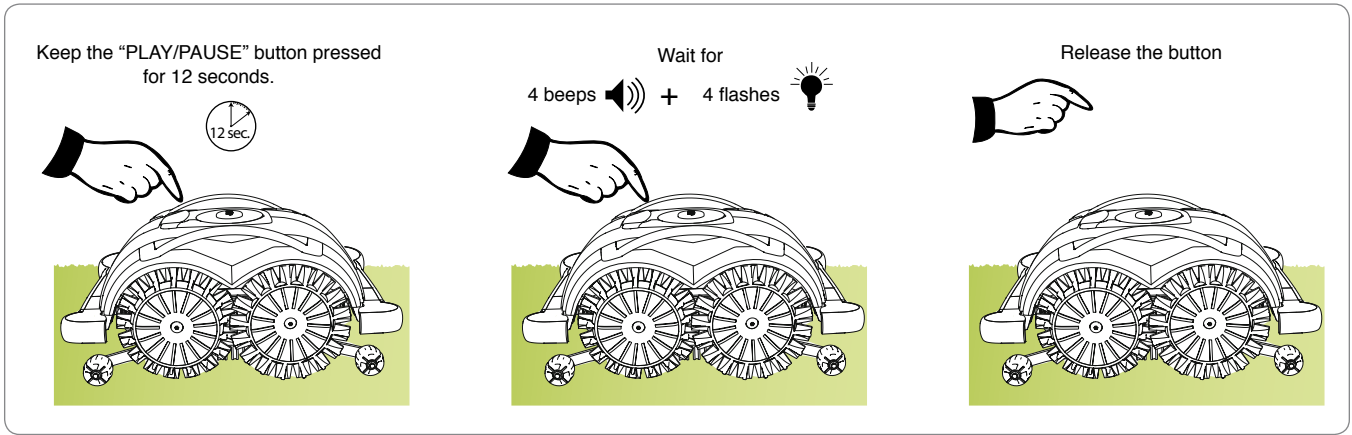

EN

ROBOT SAFETY STOP

When using the robot, you may safely stop it at any time by pressing the "STOP" key.



Important

The robot safety stop is necessary when carrying out any maintenance and repairs (for example: cleaning, adjustments to cutting height, etc.).

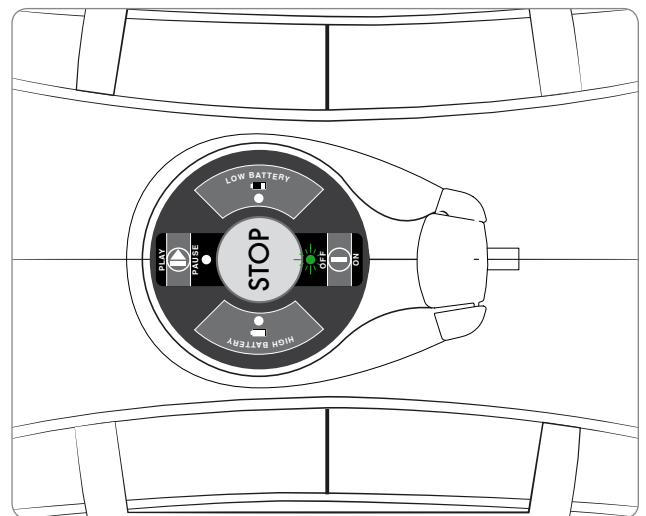

ROBOT STOP

the robot stops automatically if the following conditions are detected:

- **lawn mowed:** the sensor has detected that the lawn has been mowed and therefore, does not require further mowing. Recharge the batteries and start the robot again after one or two days based on the growth of the grass.
- **no grass present:** the grass sensors have not detected the presence of grass for an extended period.
- **discharged batteries:** the batteries have used up their operating capacity.
- **batteries in protection:** when the batteries have reached a capacity which is lower than the level of the discharged batteries, the robot completely turns off without displaying any indication. In this case, connect the robot to the recharger. The robot will not turn on immediately, as normally occurs, but only after a few minutes.

IN PAUSE

- C. PLAY/PAUSE:**
- (YELLOW LED STEADY ON)
in pause / in pause due to low battery.
 - (YELLOW LED SLOW FLASHING)
Robot in standby. Press the PLAY/PAUSE key to display the status of the LEDs.
 - ① (YELLOW LED 1 FLASH)
the lawn has been mowed.
 - ② (YELLOW LED 2 FLASHES)
no lawn present.

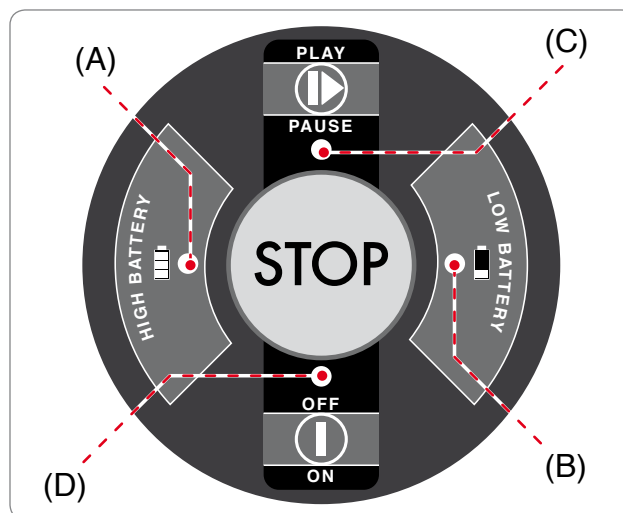

PROLONGED INACTIVITY AND RESTARTING

After a long period of inactivity of the robot and before the mowing season, it is necessary to perform a series of operations to guarantee the correct functioning at the time of reuse.

1. Fully charge the battery before winter storage. Recharge the battery at least once every five months.
2. Have the routine maintenance performed by an authorised dealer. This is essential for keeping the robot in good condition. The assistance service usually includes the following operations:
 - total cleaning of the robot, the cutting blade and all the other moving parts.
 - cleaning of the inside of the robot.
 - checking of robot functioning.
 - checking and, if necessary, replacement of any worn parts such as the cutting blade.
 - checking of the battery capacity.
 - if necessary, the dealer may also load new software.
3. Accurately clean the robot (see "Robot Cleaning").
4. Check any worn or damaged components such as the cutting blade and evaluate their replacement.
5. Store the robot in a protected and dry place with an ambient temperature between 10° and 20° C, out of reach of foreign elements (children, animals, other foreign objects, etc.). Store the robot at a temperature below 20°C in order to reduce the automatic discharge of the batteries.
6. Disconnect the power plug from the power supply unit.

Restarting

Follow these procedures before restarting the robot after a long period of inactivity:

1. Connect the plug of the power supply unit to the electrical outlet.
2. Reactivate the main electrical power supply.
3. Recharge the batteries of the robot for at least 4 hours.
4. Once the recharging has been completed, operate the robot normally.

BATTERY RECHARGE AFTER PROLONGED INACTIVITY



Danger - Attention

Do not recharge the robot in explosive and inflammable environments.

Position the robot next to the recharging zone.

1. Check that the power supply unit is connected to the electrical power (110V or 220V).
2. Lift the door of the charging connector.
3. Insert the charging connector.
4. Once connected, the robot automatically turns on to show the recharging level of the batteries. (see “meaning of LED combination”).

At the end of the charging, disconnect the robot and press “OFF/ON”.



Important

Recharge the battery at least every 5 months for lithium batteries.

OPERATING TIPS

Below are some helpful operating tips when using the robot:

- even after being suitably informed on the use of the robot, simulate some test manoeuvres on first use to identify the commands and main functions.
- check and secure the fastening screws of the main components.
- mow the lawn frequently to avoid excessive growth of the grass.
- do not use the robot to mow grass which is shorter than 1 cm (0.40 ") in respect to the cutting blade.
- if the lawn is equipped with an automatic sprinkler system, make sure the robot finishes its work cycle at least one hour before the start of the watering to prevent damage to the robot itself and to the sprinklers. Remove the robot from the lawn before turning on the sprinkler system.
- check the slope of the ground and make sure the maximum values admissible are not exceeded so that the use of the robot does not cause dangers.
- when using the robot, make sure the area to mow is clear of people (in particular, children, the elderly, or disabled people) and domestic animals to prevent safety risks to minimize chance of injury, operate the robot during times when the yard is not being used.
- do not use the robot in case of rain or strong humidity. The best results are obtained in the middle of the day.

ORDINARY MAINTENANCE

MAINTENANCE RECOMMENDATIONS



Important

During maintenance operations, use personal protection equipment indicated by the Manufacturer, especially when working on the blade. Before carrying out any maintenance, make sure the robot is turned OFF (see “Robot Safety Stop”).

SCHEDULED MAINTENANCE TABLE

Frequency	Part	Type of maintenance	Reference
Weekly	Blade	Clean and check the efficiency of the blade. Replace the blade if bent due to an impact or if it is worn out.	See “Robot Cleaning” See “Blade Replacement”
	Curb drop-off sensor	Remove any excess grass. Change the sensors if they are damaged.	See “Changing the curb drop-off sensors”.
Monthly	Robot	Clean the robot	See “Robot Cleaning”
Once a year and at the end of the mowing season	Robot	Have the robot serviced at an authorised service centre	See “Prolonged inactivity and restarting”

ROBOT CLEANING

1. Stop the robot safely (see “Robot safety stop”).



Warning – Caution

Use protective gloves to avoid the risk of injury.

2. Clean the outside surfaces of the robot with a sponge using warm water and mild detergent. Wring the sponge out well to remove any excess water before use.



Warning – Caution

Do not use a water hose to clean the robot. Water could get inside the robot and damage the components.

3. Do not use solvents or benzene so as not to damage the painted surfaces and plastic components.
4. Do not wash the internal parts of the robot and do not use jets of pressurised water so as not to damage the electric and electronic components.



Warning – Caution

In order to not cause irreversible damage to the electric and electronic components, do not immerse the robot, in water because it is not watertight.

5. Check the lower part of the robot (cutting blade area and wheels) and remove any deposits and/or residuals that may obstruct the correct functioning of the robot.
6. To remove any deposits and/or other residuals from the blade, use a suitable brush.
7. Check the level of sharpness of the cutting blade. If necessary sharpen.

TROUBLESHOOTING





The information below is designed to help identify and correct any faults and/or malfunctions which may occur during operation. Some failures can be resolved by the user; others require specific technical skills or special abilities and therefore must only be resolved by qualified personnel with certified experience gained in the specific field of intervention.



Warning – Caution

Safely stop the robot (see “Robot Safety Stop”) in case it is necessary to check the robot, in order to avoid danger of accidental blade starting.

Problem	Cause	Remedies
Abnormal vibrations The robot is very noisy	Cutting blade damaged.	Replace the blade with a new one (see “Blade Replacement”).
	Cutting blade fouled (tapes, ropes, plastic fragments, etc.).	Stop the robot safely (see “Robot safety stop”).  Warning – Caution Use protective gloves to avoid the risk of injury. Remove the debris from the blade.
	The robot was started too close to obstacles (less than 1 m. (40 ") away) or in the presence of unexpected obstacles (fallen branches, forgotten objects, etc.).	Stop the robot safely (see “Robot safety stop”). Remove the obstacles and restart the robot.
	Electric motor failure.	Have the motor repaired or replaced by the nearest authorised service centre.
	Too high grass.	Increase the cutting height (see “Cutting height adjustment”). Carry out a preliminary cutting of the area with a normal lawnmower.
The work area is not completely mowed.	Not enough work hours.	Start the robot every day.
	Cutting blade fouled with deposits and/or residuals.	Stop the robot safely (see “Robot safety stop”).  Warning – Caution Use protective gloves to avoid the risk of injury. Clean the cutting blade.
	Cutting blade worn.	Replace the blade with original spare parts (see “Blade Replacement”).
	Work area is too big compared to the actual capacity of the robot.	Adjust the work area (see “Technical Specifications”).
	The batteries are about to end their life cycle.	Replace the batteries with original spare parts.
The batteries do not recharge completely.	Recharge the batteries for at least 4 hours.	

Problem	Cause	Remedy
<p>The flashing of the LEDs signals a “wheel motor error” LED flashes.</p> <p>(1 FLASH of the green ON/OFF led - Right motor error). (2 FLASHES of the green ON/OFF led - Left motor error)</p> 	Uneven ground or ground with obstacles that impede movement.	Check that the lawn to mow is even and does not have any holes, stones or other obstacles. If so, fill in any holes and remove any obstacles (see “Preparation and defining the boundaries of the work areas”).
	One or both wheel motors has a fault.	Have the motor repaired or replaced by the nearest authorised service centre.
<p>The flashing of the LEDs signals a “motor/blade error”.</p> <p>(3 consecutive FLASHES of the green ON/OFF led).</p> 	Cutting blade damaged.	Replace the blade with a new one (see “Blade Replacement”).
	Cutting blade fouled (tape, ropes, plastic fragments, etc.).	<p>Stop the robot safely (see “Robot Safety Stop”).</p> <p> Warning – Caution</p> <p>Use protective gloves to avoid the risk of injury.</p> <p>Remove the cause of fouling of the blade.</p>
	The robot was started too close to obstacles (less than 1 m. (40.00 ") away) or in the presence of unexpected obstacles (fallen branches, forgotten objects, etc.).	<p>Stop the robot safely (see “Robot safety stop”).</p> <p>Remove the obstacles and restart the robot.</p>
	Electric motor failure.	Have the motor repaired or replaced by the nearest authorised service centre.
	Too high grass.	Increase the cutting height (see “Cutting height adjustment”). Carry out a preliminary cutting of the area with a normal lawnmower.
<p>The flashing of the LEDs signals a “tip-over error”.</p> <p>(4 consecutive FLASHES of the green ON/OFF led).</p> 	Ground with too much slope or with undefined borders.	Check the installation rules. (see “Preparation and defining the boundaries of the work areas”).
	Tip-over sensor failure.	Try to restart the robot. If the problem persists, have the robot repaired by the nearest authorised service centre.
<p>The flashing of the LEDs signals a “curb drop-off sensor error”.</p> <p>(Led (ON/OFF) 5 consecutive flashes).</p> 	When the robot is started it does not detect the curb drop-off sensor data correctly.	Clean the sensors and start the robot again. If the problem continues, decide whether to start the robot with the curb drop-off sensors off, otherwise contact the Authorised Service Centre closest to you.
The power supply unit does not turn on.	No electricity.	Check that the power supply unit is correctly connected to the power outlet.

ERROR SIGNALS

D. ON/OFF:

- ① (1 FLASH OF THE GREEN LED)
right motor error.
- ② (2 FLASHES OF THE GREEN LED)
left motor error.
- ③ (3 FLASHES OF THE GREEN LED)
blade error.
- ④ (4 FLASHES OF THE GREEN LED)
tip-over error.
- ⑤ (5 FLASHES OF THE GREEN LED)
curb drop-off sensor error.

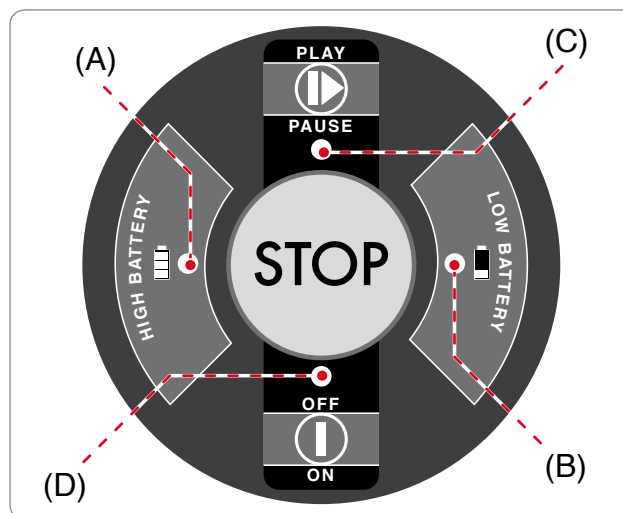

EN

PART REPLACEMENT

RECOMMENDATIONS FOR REPLACING PARTS



Important

Carry out the replacement operations and repairs according to the Manufacturer's instructions, or contact the Service Centre if these operations are not included in the manual.

BATTERY REPLACEMENT



Important

Replace the batteries at an authorised service centre.

BLADE REPLACEMENT

1. Stop the robot safely (see "Robot safety stop").



Important

Use protective gloves to avoid the risk of cutting your hands.

For replacement, use only the original blade suitable for the device.

MODEL: 7060DE0

Cutting blade code: 50_D0018_02

2. Turn over the robot and position it so as not to ruin the covering hood.
3. Unscrew the screws (B) to remove the blade (A).
4. Insert a new blade and fasten the screws.
5. Turn the robot over to its operating position.



Important

check that the slope of the blade, with the robot in the start position, is facing downwards.

INSERTING BLADE WITH SCREWS

check that the slope of the blade, with the robot in the start position, is facing downwards.

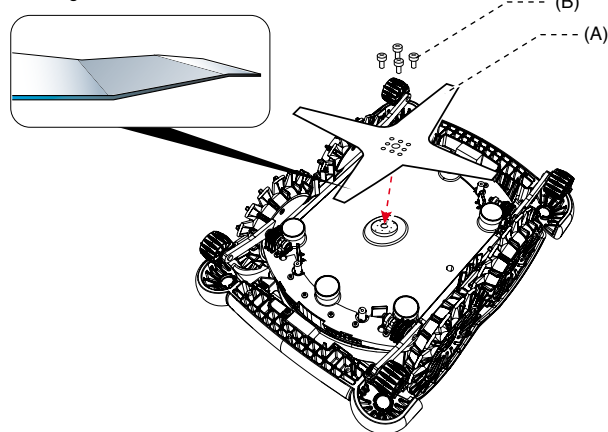

ROBOT DISPOSAL

- At the end of its useful lifespan, this product is classified as WEEE (waste electrical and electronic equipment). It must therefore not be disposed of as normal domestic waste, as mixed urban waste (undifferentiated) or as separated urban waste (differentiated).
- When it is time for disposal, the user must make sure that the product is recycled in compliance with the requirements of the local laws; in particular, electric and electronic components must be separated and sorted in authorised waste disposal centres for WEEE, or the product must be taken intact to the dealer when a new purchase is made. Abusive disposal of WEEE is punished by fines established by laws in force in the areas where said disposal occurs.
- Dangerous substances contained in electric and electronic equipment have potentially harmful effects on the environment and people's health so the user has a fundamental role in contributing to reuse, recycling and any other way of recovering WEEE.
- All parts, to be specifically separated and disposed of, are marked..



Danger - Attention

WEEE - Waste Electric and Electronic Equipment (WEEE) can contain dangerous substances with potentially harmful effects on the environment and people's health. WEEE must be disposed of correctly and only in specific disposal centres.

- Packaging - Product packaging is made with recyclable materials and must be disposed of in a sustainable manner in special disposal containers or authorised waste disposal centres.
- Batteries - Old or exhausted batteries contain harmful substances for the environment and people's health so must not be disposed of as normal domestic waste. The user must dispose of batteries in a sustainable way, in specific disposal containers or in authorised waste disposal centres.



ZUCCHETTI Centro Sistemi S.p.A. Via Lungarno 305/A Terranuova B.ni (AR) ITALY

declares and assumes liability that the product:

battery-powered automatic lawnmower robot, model 7060DE0, complies with the basic requisites for safety, health and environmental protection provided for by the following European Union directives:

Machinery directive 2006/42/EC, electromagnetic compatibility directive 2014/30/EC, Radio (RED) directive 2014/53/UE, RoHS directive 2011/65/EC, WEEE directive 2012/19/EU, directive for noise emission in the environment 2005/88/EC;

complies with the following harmonised standards:

EN 50636-2-107:2015 and EN 60335-1:2012 + A11:2014 (**safety**);

EN 62233:2008 (**electromagnetic fields**);

EN 55014-1:2008 + A1:2010 + A2:2012 (**emission**);

EN 61000-3-2:2015 and EN 61000-3-3:2014 (**emission**);

EN 55014-2:2015 (**immunity**);

EN 50419:2006 (**WEEE – Equipment marking**)

ETSI EN 301 489-1 V1.9.2 (**Electromagnetic compatibility**)

ETSI EN 301 489-17 V1.3.2 (**Electromagnetic compatibility**)

ETSI EN 300 328 V1.9.1 (**Radio Spectrum Efficiency**)

DRAFT

ETSI EN 303 447 V1.1.0_0.0.2 (2017-04)

also declares that, pursuant to directive 2005/88/EC, the LWA sound power level, out of a significant sample is 65 dB ± 2.0 dB (weighted on A curve and referred to 1 pW), that the guaranteed LWA sound power level is less than 67 dB (weighted on A curve and referred to 1 pW) and that the technical folders in compliance with directives 2005/88/EC and 2006/42/EC are available c/o Zucchetti Centro Sistemi S.p.A. via Lungarno 305/a, Terranuova B.ni (ar), Italy.

Terranuova B.ni 02/10/2017

Bernini Fabrizio
(CEO)

NOTES

EN

